

Stromberg SMUX2R retrofit avr



1-12-2011

retrofit SMUX2R avr

Stromberg HSPTL generators according below schematic diagram are fitted with SMUX2R avr's.

Note that externally from the actual avr's differences may exist !

The retrofit avr, fits on the same physical place, and fits the genuine connector / plug.



Pictures of the genuine avr

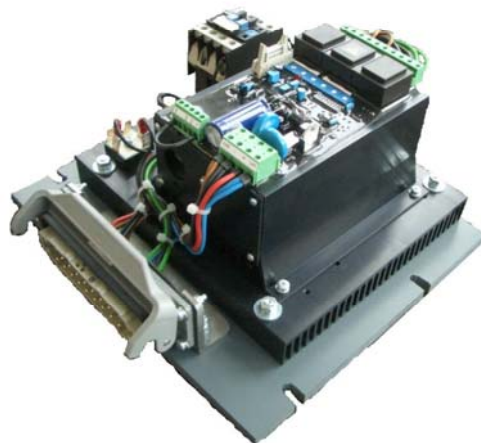

Picture of the retrofit avr

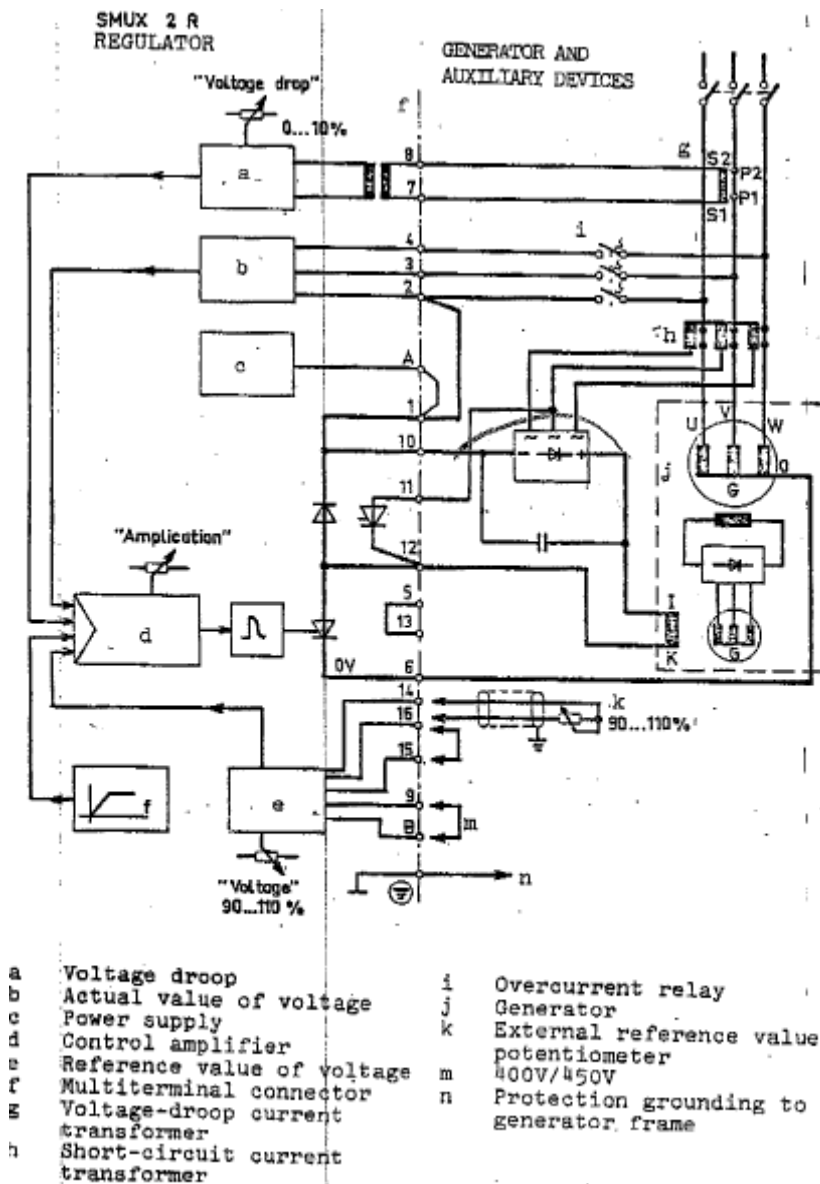

Fig. 2. Block diagram of the SMUX 2 R regulator.

Genuine schematic diagram of the HSPTL (smux controlled) generator

Droop CT connection:

The SMUX 2R replacement avr is build for acceptance / connection to a 1 Amp secondary Droop CT at clockwise direction.

(CT tagged **g** in the manual of the AVR / Generator, fitted in the V Phase)

If the generator which is to be equipped with the SMUX 2R replacement AVR has a current transformer with a secondary current of 5 Amps, you should use the adaptation current transformer 5:1 Amps.

For adjustments: see the attached manual 3TX20 avr.

Dimensions:

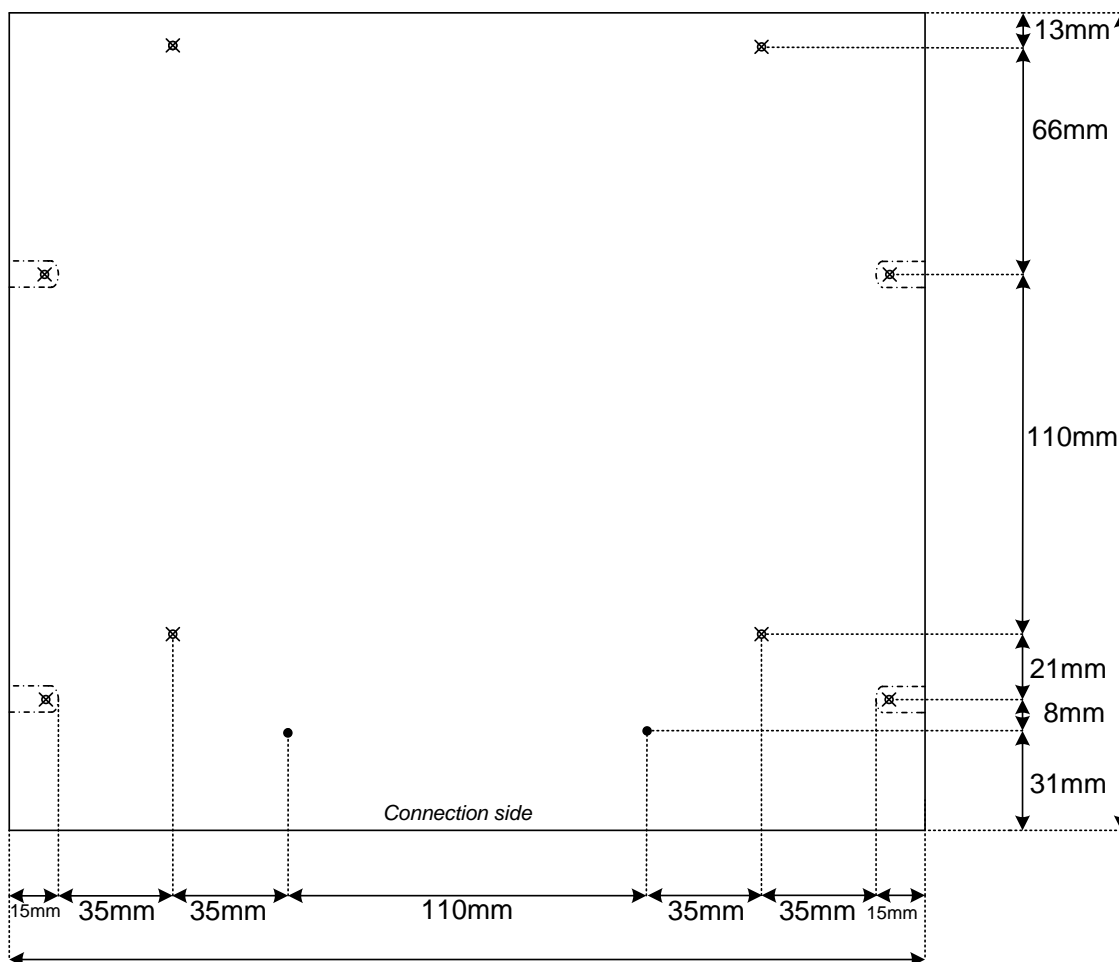

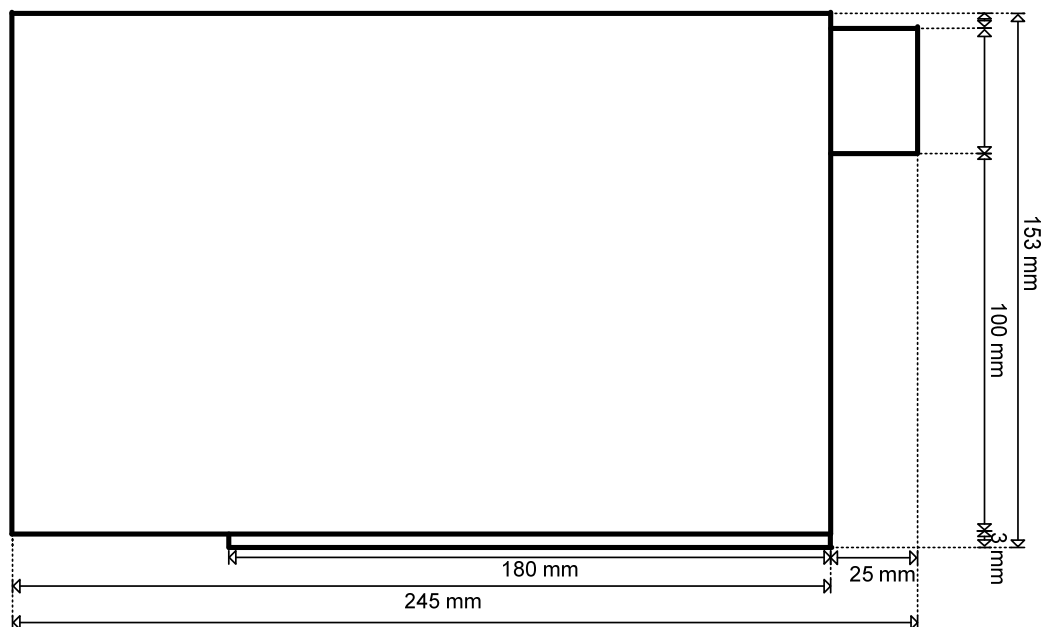
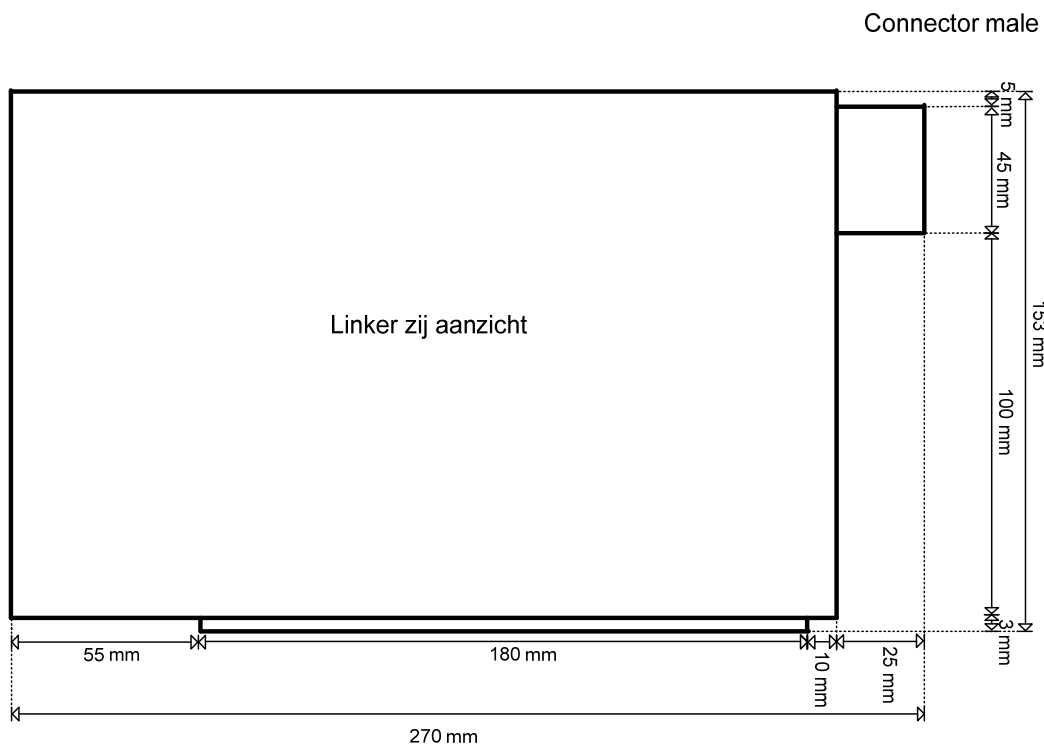

Stromberg SMUX2R retrofit avr



1-12-2011

retrofit SMUX2R avr



SMUX2R connector side avr male plug:

International Sales

Experts in Rotating Energy

Rafeining ehf
Hafnarfjordur - Iceland
Tel: +354 565 3049
Fax: +354 565 3048
E-mail: rafeining@rafeining.is
cont: Fridrik Gardarson

Frydenbo Electric A/S
Bergen - Norway
Tel: + 47 55 34 91 00
Fax: + 47 55 34 91 10
E-mail: firma.tel@frydenboe.no
cont: Bjorn Gjesdahl,
FrodeAnvinsen

Myren & Co. AB
Askim - Sweden
Tel: +46 317481860
Fax: +46 317481870
E-mail: mvren@mvren.com
cont: Claes Hugoson, Mats
Andersson

Marel-Serwis
Scezzin, Poland
Tel: + 48 607331555
Fax: + 48 58 668 44 66
E-mail: foreign@marel.szczecin.pl
cont: Michael Samborsky, Jerzy
Wrukowski

MJR Controls
Stockton On Tees, UK
Tel: +44 1642 762 151
Fax: +44 1642 762 502
E-mail: enquiries@mjrcontrols.com
cont: Chris Millner, Jonathan
Marshall

Yneldo Electronics
Roodepoort - South Africa
Tel: +27(0)117637053
Fax: +27(0)117634212
E-mail: yneldo@yneldo.com
cont: Paul Reinten

KDU World Wide Technical Services
Sharjah - United Arab Emirates
Tel: +971-6-5575480
Fax: +971-6-5575490
E-mail: kdutech@kdutech.ae
cont: Madhu, Ralph Cabral

Cyclelect Electrical Eng.
Singapore
Tel: +65 6868 6013
Fax: +65 6863 6260
E-mail: heng.p@cyclelect.com.sg
cont: Pauline Heng, Richard
Cheong

Dan-Elec
Gdynia, Poland
Tel: + 48 58 668 44 00
Fax: + 48 58 668 44 66
E-mail: info@an-elec.pl
cont: M.Stolarczyk

EMRI Electronics bv
Morsestraat 10
6716 AH
EDE
The Netherlands
T: +31 318 620 427
F: +31 318 634 615
info@emri.nl

3TX20 V2.0

- Manual



Jan '08



READ THE MANUAL PRIOR BEFORE COMMISSIONING

Application, use or commissioning can only take place by acceptance of the general deliveries conditions of EMRI by which are available upon request.

Check WWW.EMRI.NL for latest manual / updates / modifications or general installation information.

INTRODUCTION

This manual provides information for use and application of the product.

This information consists of

- Warnings
- Layout
- Absolute maximum ratings
- Commissioning information
- Dipswitch and potentiometer settings
- Layout terminals
- General installation information and environmental aspects Application Diagrams

WARNING

To avoid personal injury or equipment damage:
Mounting, connecting and commissioning, should be performed by electrical qualified personal only.

WARNING

Never work on a LIVE generator.

The manual does not cover all technical details of the product. Also may specifications being modified by the manufacturer without notice.

For further information, the manufacturer should be contacted.



Due to liability reasons, EMRI products may not be used, applied or commissioned in equipment residing under law of the United States of America or Canada. Neither may EMRI products be applied or commissioned by any person residing under law of the United States of America or Canada.



ELECTRICAL DANGER

LIVE VOLTAGE

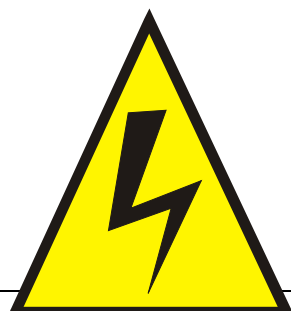

ELECTRICAL DANGER

LIVE VOLTAGE

Introduction

This manual provides information for use and application of the EMRI 3TX20.

This information consists of

- AVR Layout
- Absolute maximum ratings
- Commissioning information
- Dipswitch and potentiometer settings
- Layout terminals
- General installation information and environmental aspects
- Application Diagrams

WARNING

To avoid personal injury or equipment damage:
Mounting, connecting and commissioning, should be performed by electrical trained and qualified personal only.

WARNING

Never work on a LIVE generator.
Unless there is another person present who can switch of the power supply or stop the engine

The manual does not cover all technical details of the product. Also specifications may be modified by the manufacturer without notice. For further information, the manufacturer should be contacted.



**ELECTRICAL HAZARDOUS VOLTAGES
DANGEROUS
DO NOT OPERATE WHEN NOT
FAMILIAR WITH
GENERATORS**



AVR Layout

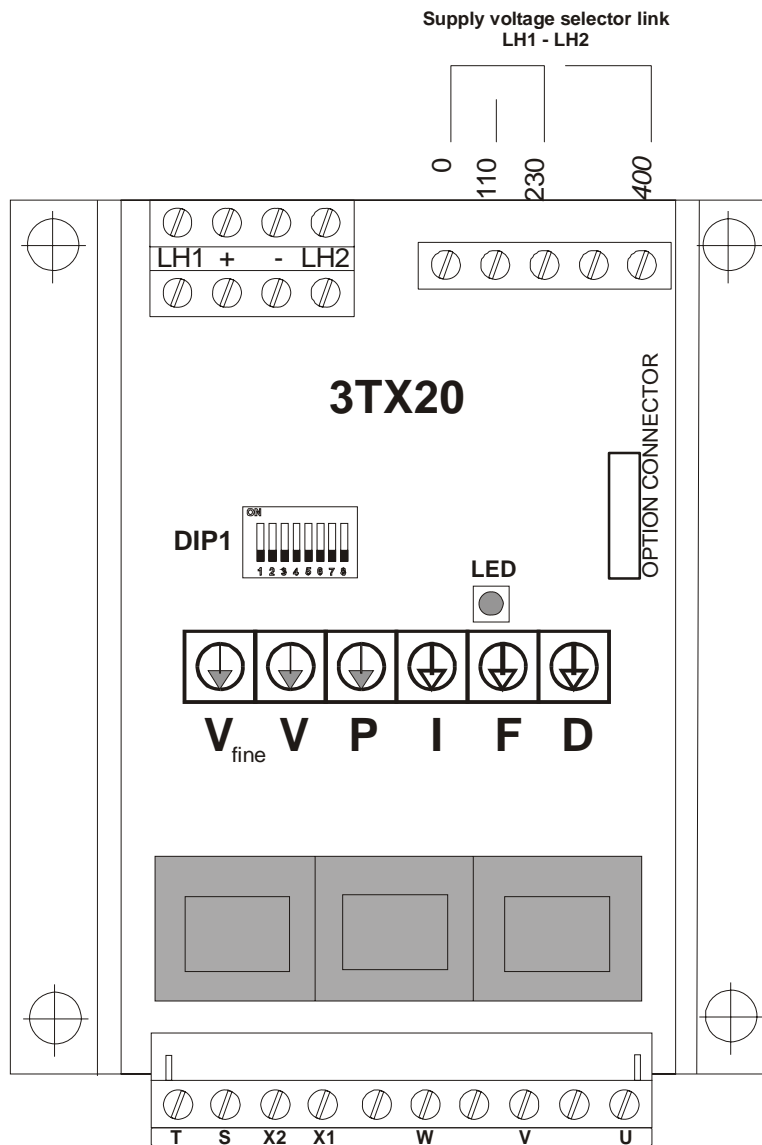

THE AVR IS PROTECTED FROM THE ENVIRONMENT BY AN EPOXY COATING

DIMENSIONS :
L X W X H
160 X 145 X 110 MM
WEIGHT:
1850 GR.

Absolute maximum ratings / Specifications

SYMBOL	PARAMETER	CONDITION	MIN.	MAX.	UNIT
U_U, U_V, U_W	Voltage sensing input	< 30 s.	-	500	V _{AC}
Accuracy	Voltage			1 %	
I_{x1}, I_{x2}	Droop input			0,75	A _{AC}
I_+, I_-	AVR field current Forced < 0.5 sec.			20 40	A _{DC}
LH1-LH2 110 230 400	Supply input		30* ¹ 55* ¹ 115* ¹	50 / 60 115/140 230/260 440/480	Hertz V
R_{field}	Field resistance	Supply 110 V Supply 230 V Supply 400 V	2.5 5 15	- -	Ω Ω
$V_{se} *1$	Self excitation (S.E.)	> 5 V	3	10	V
T_{AMB}	Operating ambient temperature	non condensing	0	+50	°C
T_{STG}	Storage temperature	non condensing	-45	+150	°C

*1 depending upon self excitation behaviour of the generator

Supply Voltage selection link

Link 110Volt			
50Hertz	30V	90V	115V
60Hertz	30V	90V	140V
Link 230Volt			
50Hertz	55V	175V	230V
60Hertz	55V	175V	260V
Link 440Volt *²			
50Hertz	115V	330V	440V
60Hertz	115V	330V	480V

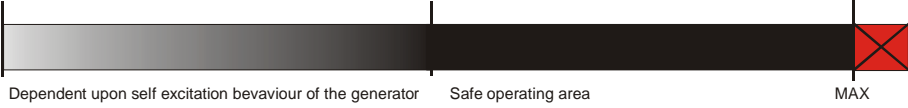

Select the supply voltage range so that MAX. value will never be exceeded

*² Use this high voltage input only upon low current and/or higher voltage exciter value's
ask the manufacturer when in doubt

Commissioning information

The unit should be installed with respect to the environmental specifications as well as the rules mentioned in the General installation information. Dipswitch settings may not be altered when operating but need to be set beforehand. For safety reasons the voltage-LEVEL potentiometer is best turned completely counter clockwise, to start at the lowest possible voltage. Potentiometers P and I should be turned to centre position. As a reference the chart below shows generator voltages for different configurations. The option connector should be occupied with the supplied dummy connector, containing some essential inter connections.

Dipswitch and potentiometer settings

Carefully determine the correct way of connecting the AVR from the suitable application diagram.

Incorrect installation could lead to hazardous situations and damage to generator and AVR. When dipswitch 2 is set to 230V sensing (on), the AVR expects 200 – 325V at it's inputs. When dipswitch 3 is set to 280V sensing (on), the AVR expects 225 – 375V at it's inputs. When dipswitch 2 and 3 are **not** set, the AVR expects 280 – 480V at it's inputs. When dipswitch 1 is set, the self excitation circuit is activated, and the generator excites with residual voltage *1

DIPSWITCH	1	2	3	4	5	6	7	8
ON	SELF. EXCITED	230V SENSING RANGE	280V SENSING RANGE	PHASE LOSS ENABLED	S & T SHORTENED	NOT USED	NOT USED	UNDERSPEED. PROTECTION ENABLED
OFF	NOT SELF EXCITED			PHASE LOSS DISABLED	S & T OPEN			UNDERSPEED. PROTECTION DISENABLED



POTENTIOMETER	FUNCTION
V COURSE	GENERATOR VOLTAGE ADJUSTMENT
V FINE	GENERATOR VOLTAGE ADJUSTMENT
P-STABILITY	PROPORTIONAL GAIN ADJUSTMENT
I-STABILITY	PROPORTIONAL GAIN ADJUSTMENT
F-UNDERSPEED	UNDERSPEED TRIP LEVEL SEE NOTE
DROOP	VOLTAGE DROOP (PARALLEL OPERATION)

Note: Too low setting F-Underspeed or disabling Underspeed protection may cause damage to the generator or the AVR due to incorrect voltage / frequency ratio.

Layout terminals

TERMINAL	CONNECTIONS
U,V,W	THREE PHASE SENSING
X1,X2	DROOP CT CONNECTIONS (PARALLEL OPERATION)
S,T	EXTERNAL VOLTAGE SETTING POTENTIOMETER
LH1,LH2	SUPPLY VOLTAGE FOR AVR
0,110,230,400	SUPPLY VOLTAGE SELECTOR
+,-	EXCITER FIELD CONNECTION

Fuse

20 A	20 AT, 500 V, 10.3 X 38.1 MM
------	------------------------------

Factory Settings Dipswitches

DIPSWITCH	1	2	3	4	5	6	7	8
ON	SELF. EXCITED				S & T SHORTENED	NOT USED	NOT USED	UNDERSPEED. PROTECTION ENABLED
OFF		OFF	OFF	PHASE LOSS DISABLED				

General installation information

Absolute Maximum Ratings

- The Absolute Maximum Ratings are those limits for the device that, if exceeded, will likely damage the device. Exceeding the absolute maximum ratings voids any warranty and/or guarantee.

Mounting

- Mounting of the product should be done in such a way that the absolute maximum ambient temperature rating of the product will never be exceeded.
- Mounting of the product should be done in such a way that maximum cooling (direction of cooling ribs and direction of airflow) is achieved.
- Mounting of the product should be done in such a way that no humid air can flow through the product or condensation occurs.
- Mounting of the product should be done in such a way that dust or other materials or residue will not remain in or on the product.
- Mounting of the product should be done in such a way that the maximum vibration is not exceeded.
- Mounting of the product should be done in such a way that personal contact with persons is impossible.

Wiring

- Diameter size of the wiring should be enough to carry the expected current. Wire insulation should be enough to withstand the expected operating voltages and temperatures.
- To improve EMC emission and immunity, care should be taken for the lay out of the wiring. This in respect to all wiring in the installation.
- Keep current carrying wires as short as possible.
- Keep wires carrying a total sum of zero Ampere close to each other, or in one single cable. E.g. U, V, W or + and -, or Phase and neutral, X1 and X2.
- Avoid current carrying conductors next to sensing or control wiring. Especially current controlled by SCR's or PWM controlled transistors.
- If sensitive sensing signal cables need to be laid across distance along other cabling, shielded cable is preferred.
Keep the shield as long as possible and the wiring outside the shield as short as possible. Do not solder or shrink the shield to a regular wire. Connect the original shield to ground with a as large as possible contact surface.

Additional installation information

- When the product is supplied by means of a transformer, it should never be an auto-transformer. Auto-transformers react as voltage sweep up coil and may cause high voltage peaks.
- Standard fit capacitors or over-voltage suppressers across F+ and F- or exciter field terminals inside the generator should be removed.
- When the product is supplied by means of a transformer, it should be able to carry at least the maximum expected current. Advisable is, to have a transformer which can carry twice the maximum expected current. Inductive loads make voltage sags and peaks into the secondary voltage of a transformer, from which the device may malfunction.
- It is not recommended to apply switches in dc outputs. It is preferred to use switches in the ac supply inputs of devices. In case it is unavoidable to have switches in the dc output of a device, action must be taken to avoid over voltage damage to the device due to contact arcing. Use a voltage suppressor across the output.
- It is not recommended to apply switches or fuses in the sensing lines. Defects can cause high voltage situations due to over-excitation.
- When using a step down transformer in medium or high voltage generators, the transformer should be three phase (if three phase sensing), and the transformer should be suitable for acting as a sensing transformer. If the transformer is unloaded, connect a resistor to avoid voltage waveform distortion.
- The phase relation from the generator to the AVR is important. Also when voltage transformers and/ or current transformers are installed.
- When using a step down or insulation transformer in the droop circuit, phase relation from the generator to the AVR is important.
- CT's wiring, connected to the AVR should never be grounded.
- Always disconnect electronic products, circuits and people before checking the insulation resistance (Megger check).
- Due to differences in generators impedance's, EMC behaviour is not predictable. Therefore the commissioner / installer should be aware of proper and correct installation.
- Large, highly inductive, exciter stator windings can cause destructive high voltage peaks. Adding a resistor from 10 to 20 times the exciter stator field resistance reduces voltage spikes. If necessary, a RC filter can be fitted additionally
- Upon problems during commissioning, faulty behaviour or defects in the generator, consult the fault finding manual at our web site
- Some advises may be overdone or seem extraordinary, but since the electrical rules are the same everywhere, these advises are given.

Application Diagram

230 Volt Supply

GENERATOR OUTPUT, ROTATION CLOCKWISE

N U V W

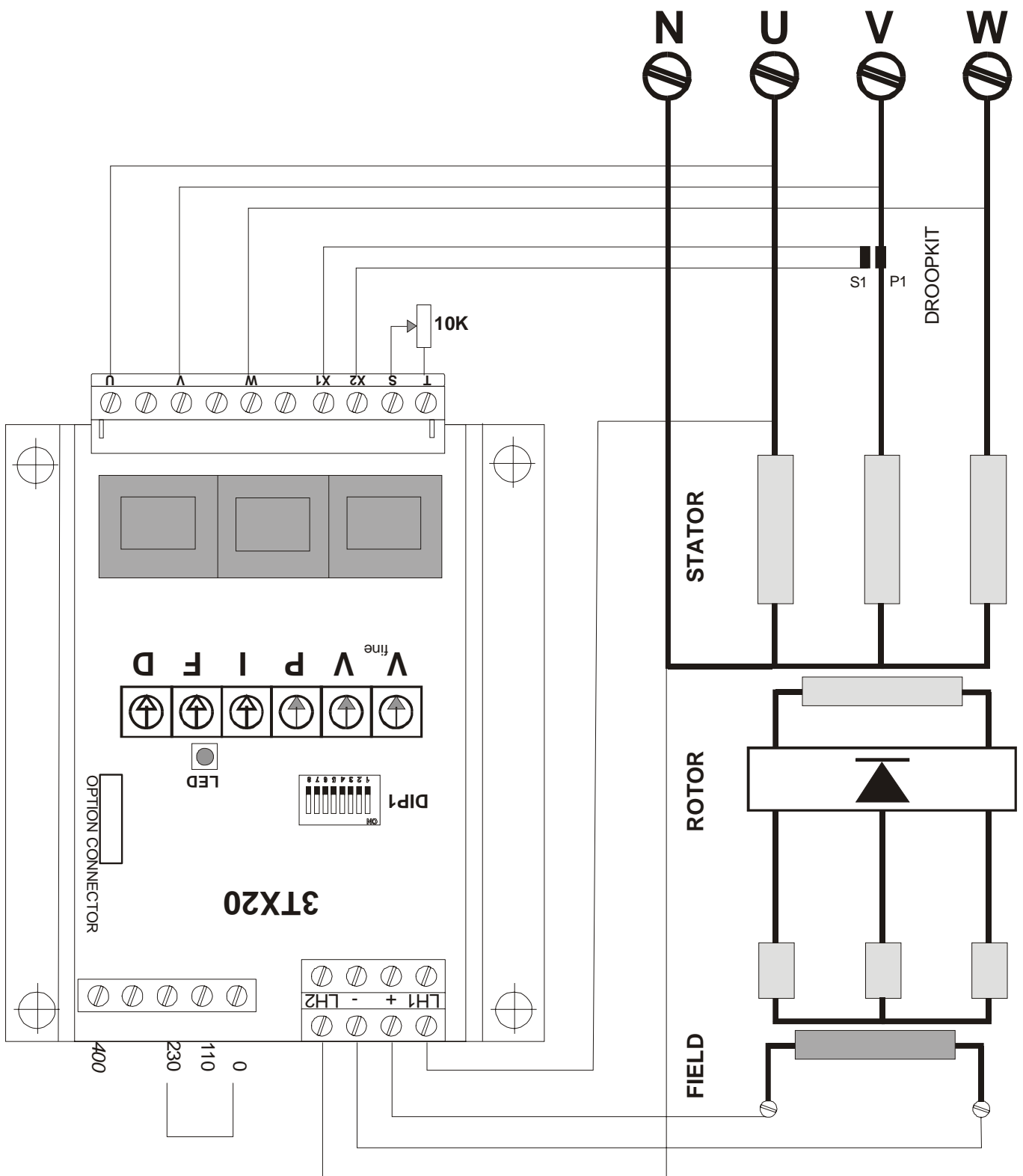

Application Diagram

Caterpillar 400-450 Volt
GENERATOR OUTPUT, ROTATION
CLOCKWISE

CATERPILLAR

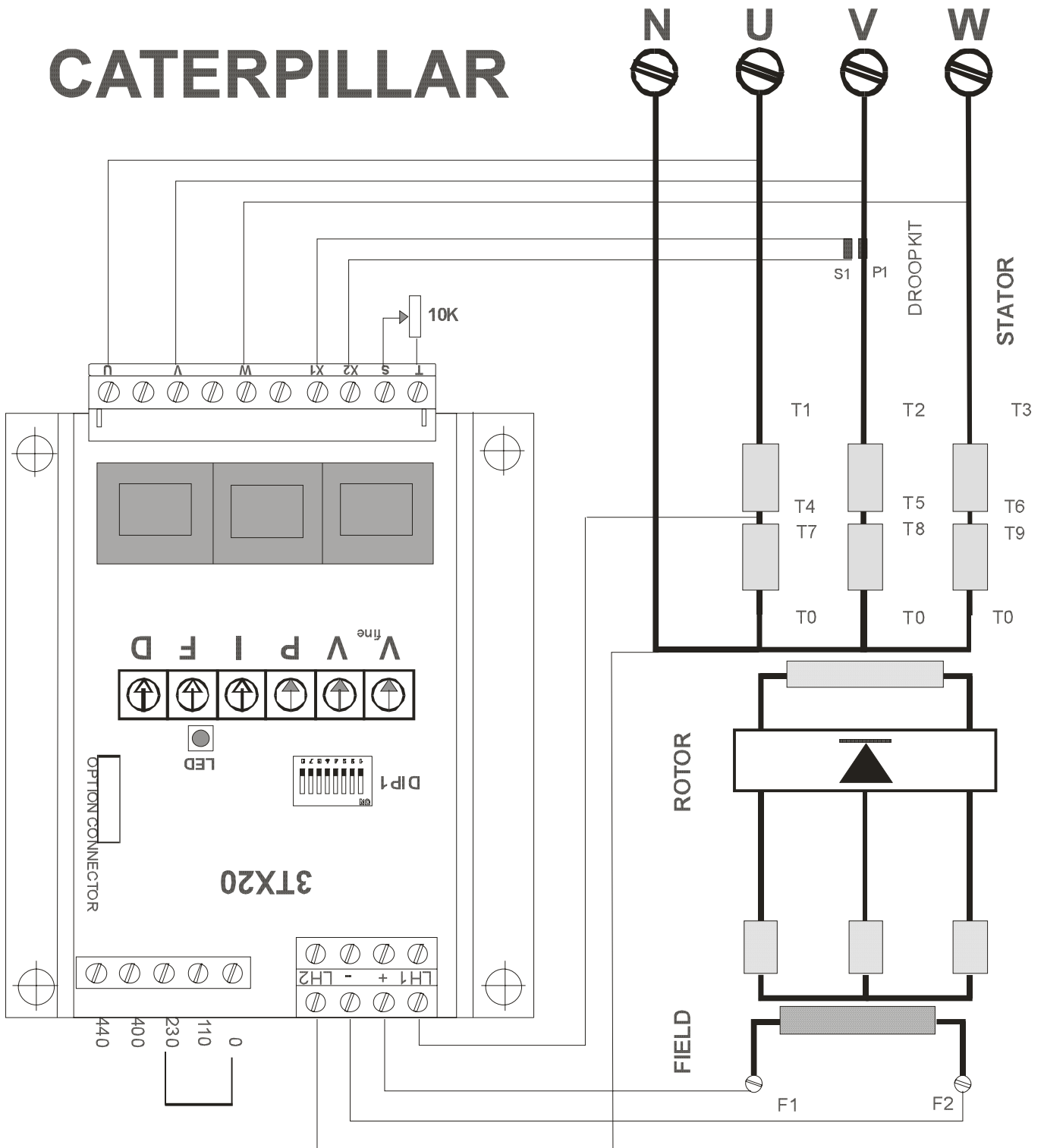

Application Diagram

Insulation Transformer
GENERATOR OUTPUT, ROTATION
CLOCKWISE

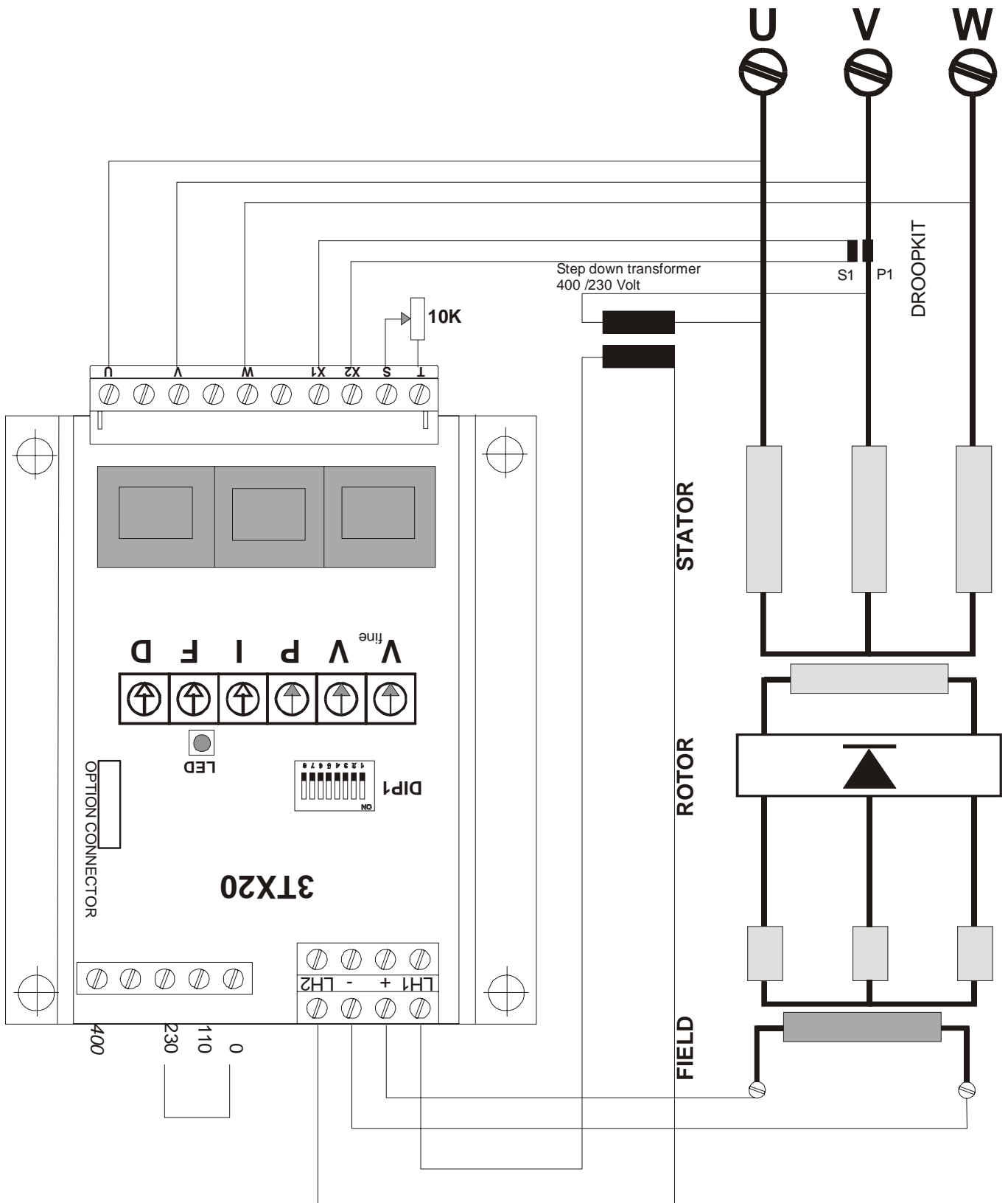

Application Diagram

Nishishiba

**GENERATOR OUTPUT, ROTATION
CLOCKWISE**

NISHISHIBA GENSET
1063 kVA, 440 Volt, 1395 Amp, exc. < 10 Amp
proposal if droop circuit cannot be implemented

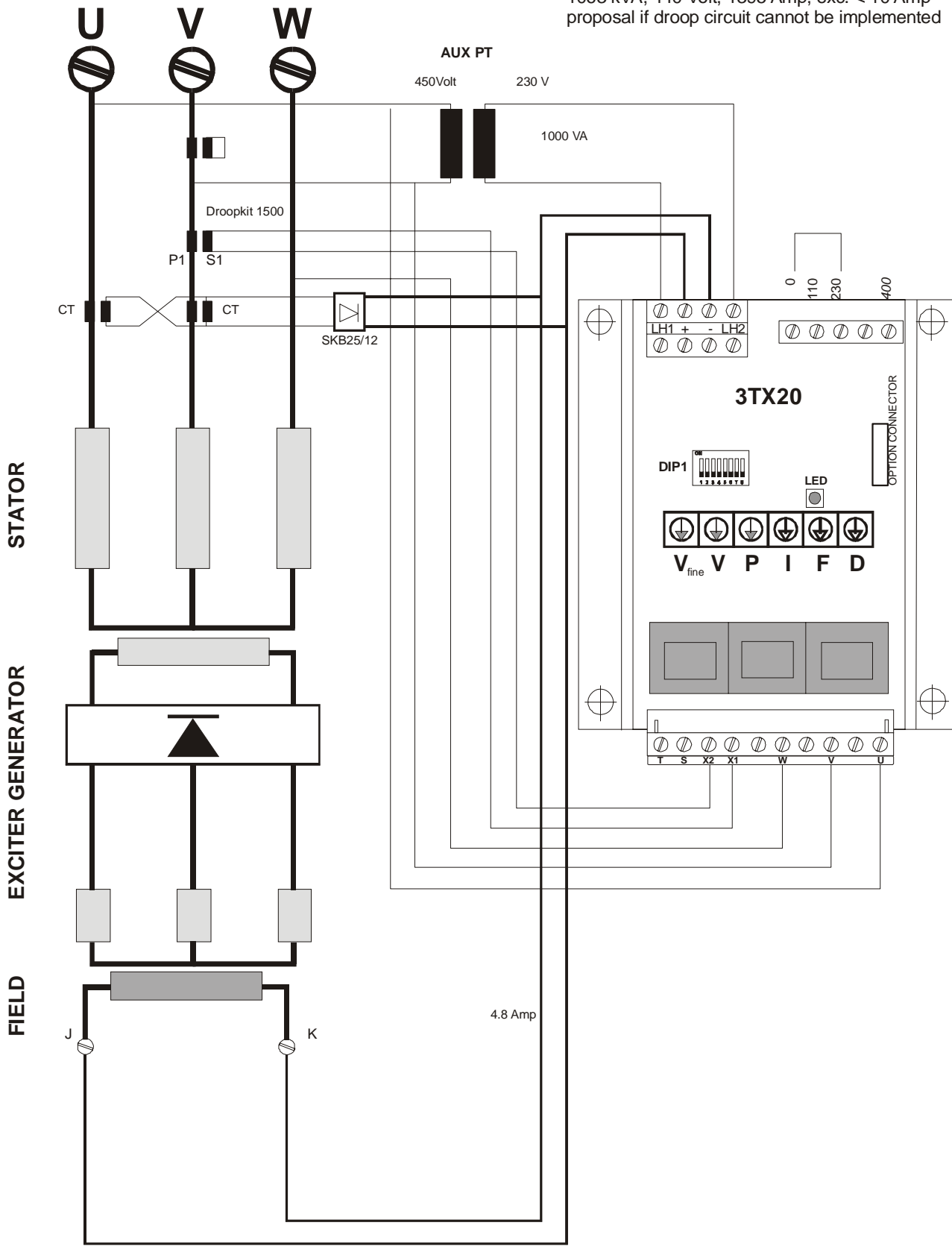

Application Diagram

NEBB STROMBERG SMUX2R

GENERATOR OUTPUT, ROTATION
CLOCKWISE

SMUX 2R Replacement by 3TX20

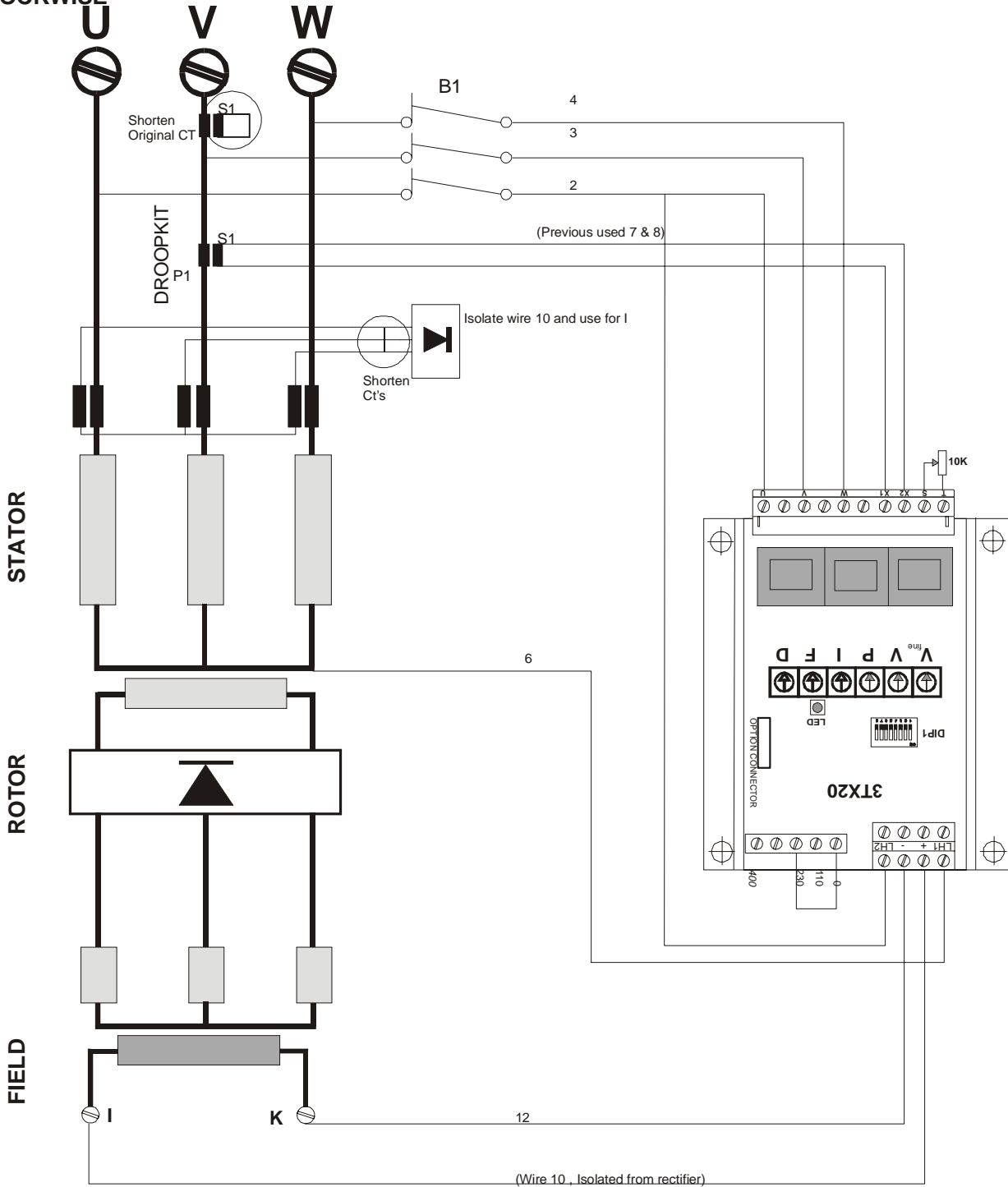

The numbers refer to the SMUX connector pin number

- 1) Isolate the wires 7 and 8 from the original CT and connect them to new DROOPKIT. Shorten old CT !!
- 2) Shorten the input from the rectifier from the compound transformers system, and isolate wire 10, and bring it only to the + (I) of the exciter field and to the + from the AVR
- 3) Connect other wiring as indicated

Application Diagram

NEBB STROMBERG SMUX3R1

GENERATOR OUTPUT, ROTATION
CLOCKWISE

SMUX 3R1 Replacement by 3TX20

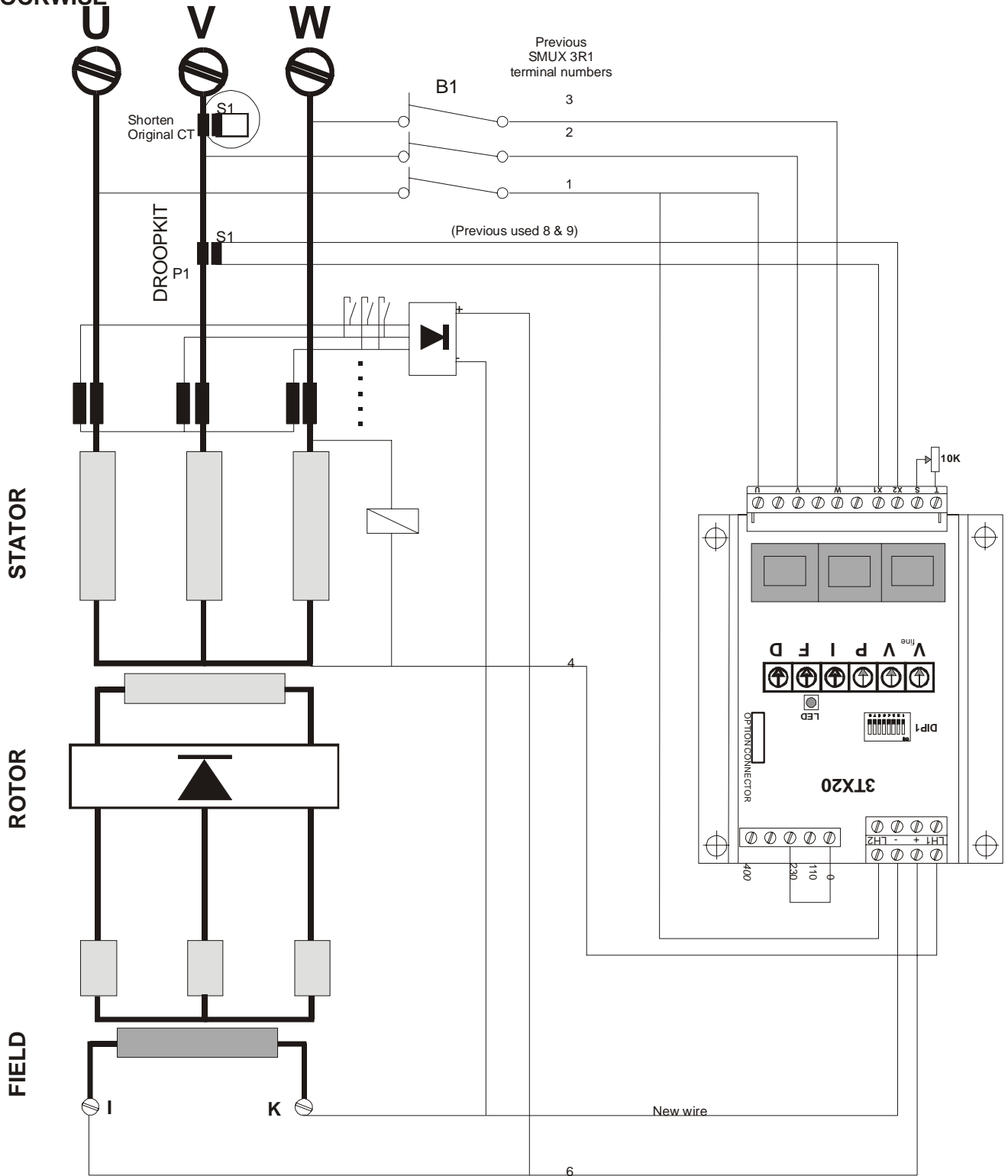

Application Diagram

Daihatsu Mitsubishi

GENERATOR OUTPUT, ROTATION
CLOCKWISE

DAIHATSU / MITSUBISHI GENSET
1000 kVA, 450 Volt, 1283 Amp, exc. 55 Volt, 7 Amp
Exciter generator 25 kVA (3 x 100 V)

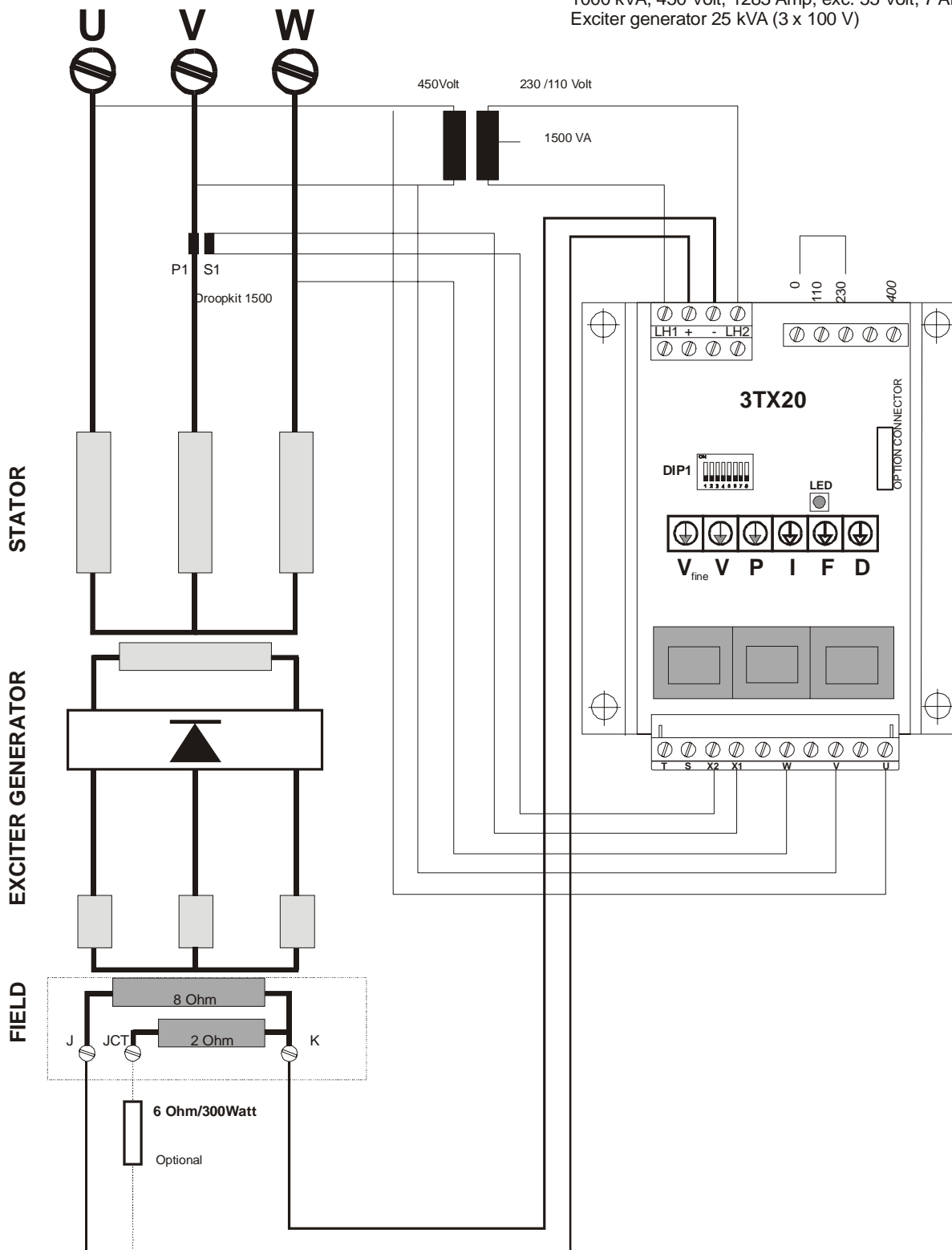

Application Diagram
**GENERATOR OUTPUT, ROTATION
 CLOCKWISE**

NEBB SF7

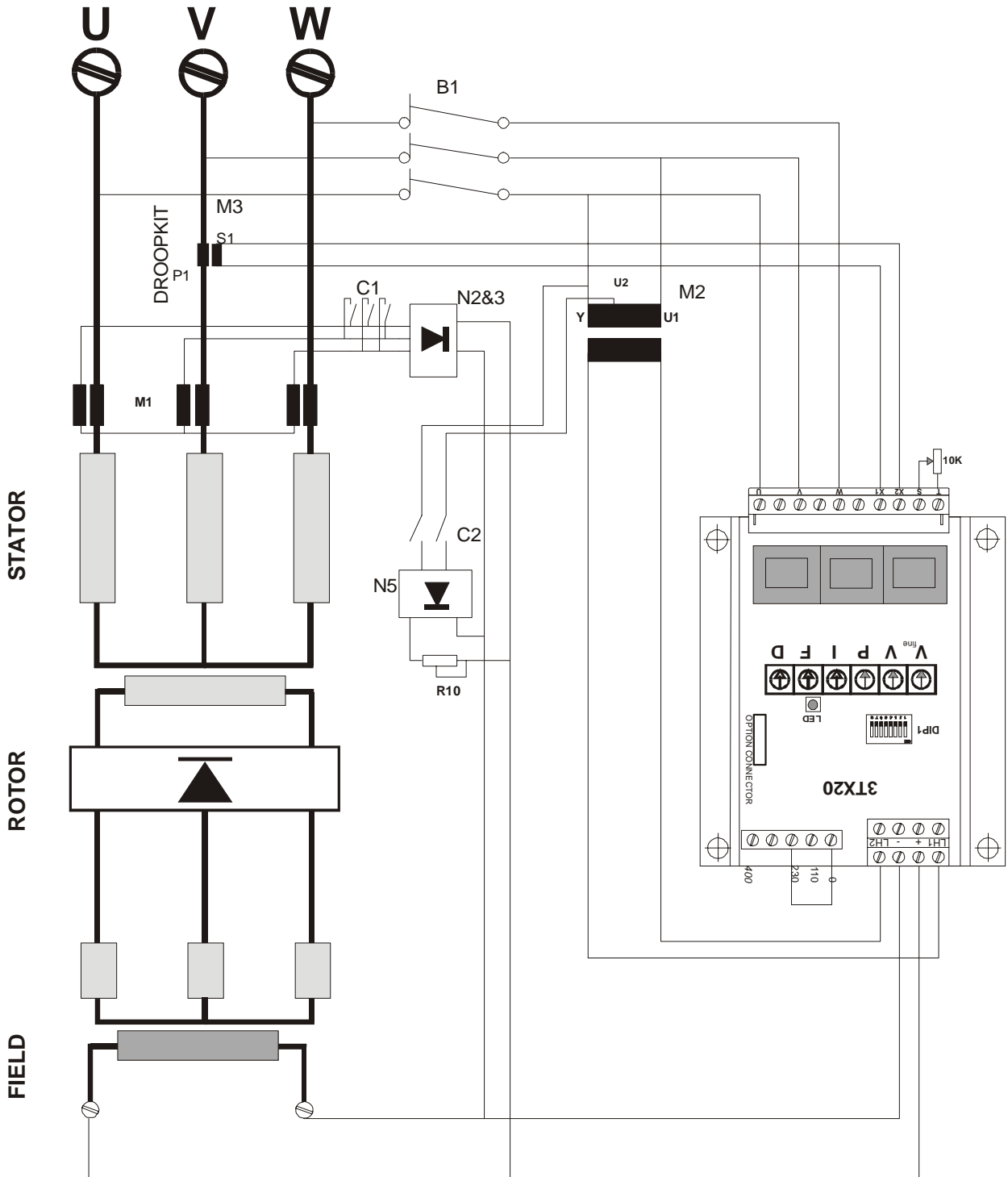

**C1 AND C2 MUST BE ENERGIZED ON > 40 % OF Unominal, AND
 DE-ENERGIZED WHEN < 40 % OF Unominal**

NEBB SF7 REPLACEMENT WITH / 3TX20 / OR LX10 / OR 3FLASR11

Application Diagram

> 480 Volt

GENERATOR OUTPUT, ROTATION
CLOCKWISE

V gen > 480 Volt 60 Hertz

Measuring step down transformer

